

brera

Sofa

brera ricerca ed eleganza

brera philosophy

Qualità Gamma Design

sono alcuni dei pilastri che caratterizzano la missione di noi della Brera.

Assoluta qualità dei materiali e delle lavorazioni.

Centinaia di rivestimenti in materiali differenti, dalla pelle all'ecopelle, al velluto, dal puro cotone!

Le sapienti ed artigianali lavorazioni esaltano ulteriormente la qualità dei materiali selezionati;

Le strutture realizzate con materiali di primissima scelta assicurano resistenza e comfort.

Gamma

La collezione offre modelli con carattere e design assolutamente marcato, profondamente differenti tra loro.

Preziosi e ricchi di segni forti, i divani Brera miscelano sapientemente tradizione, design e innovazione.

Quality Product range Design

are some of the pillars that characterize the mission of us of the Brera.

Absolute quality of materials and workmanship.

Hundreds of upholstery in different materials, from leather to eco-leather, velvet, pure cotton!

The skilful and artisanal workmanship further enhances the quality of the selected materials;

The structures made with top quality materials ensure resistance and comfort.

Range

The collection offers models with absolutely character and design marked, profoundly different from each other.

Precious and full of strong signs, the Brera sofas wisely mix tradition, design and innovation.

brera sofa

MODEL 1 pag. 8

MODEL 2 pag. 24

MODEL 3 pag. 40

Elementi liberamente componibili realizzati in variante di colore o monocromatici con tessuto, pelle, ecopelle o microfibra della collezione Brera.

Sectional pieces for unlimited configurations and multiple monochromatic or colorful covers to choose from fabric, leather, eco-leather or microfiber of Brera collection.



MODEL 1

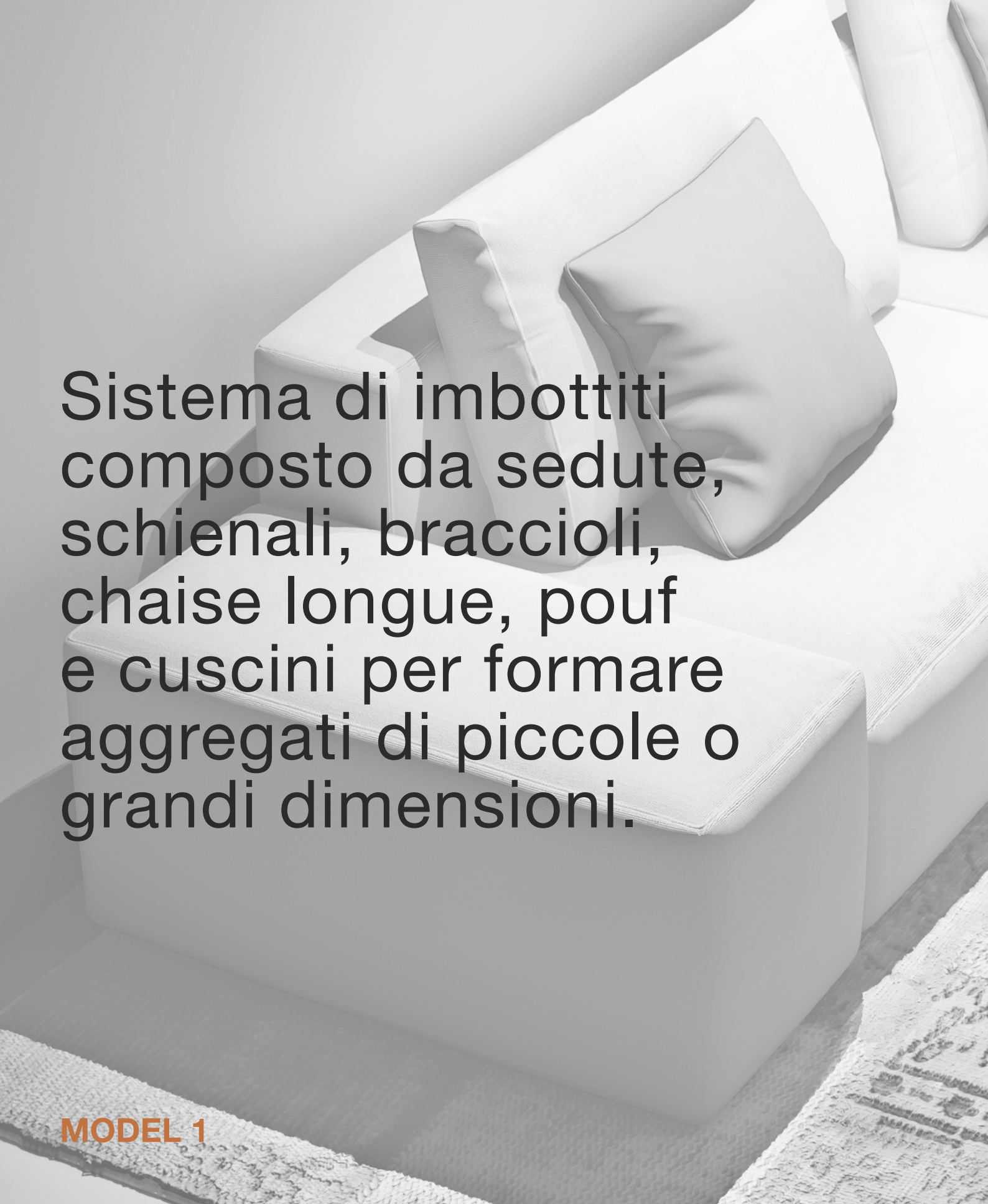

Sistema di imbottiti
composto da sedute,
schienali, braccioli,
chaise longue, pouf
e cuscini per formare
aggregati di piccole o
grandi dimensioni.

MODEL 1

*System of upholstered
pieces for seats,
backrest, armrest
chaise longue, ottomans
and pillows to create
configurations for small
and large dimensions.*







COMPOSIZIONE 330 CLCA
COMPOSITION 330 CLCA





COMPOSIZIONE 240 AA

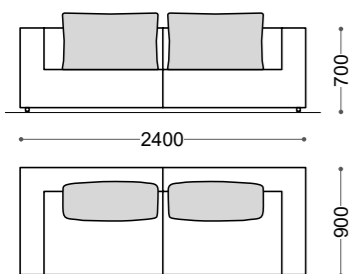

COMPOSIZIONE 285 PCA

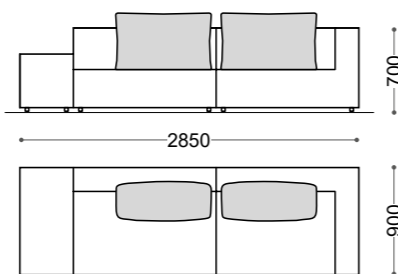

COMPOSIZIONE 270 CLCA240AC

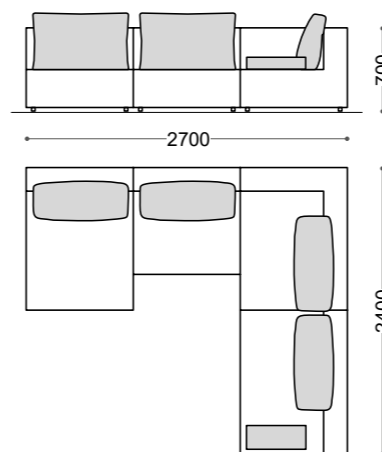

COMPOSIZIONE 300 ACA 285 ACP

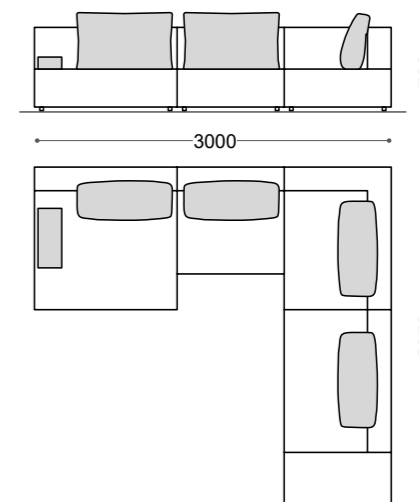

COMPOSIZIONE 255 PCA

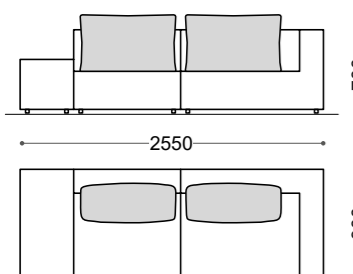

COMPOSIZIONE 330 CLCA

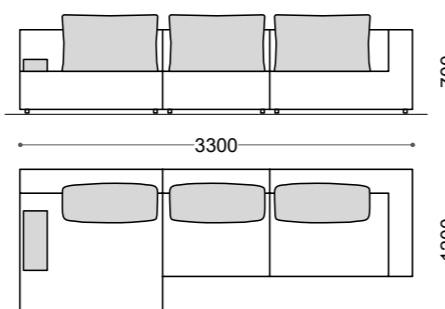

COMPOSIZIONE 330 CLCA 300 ACA

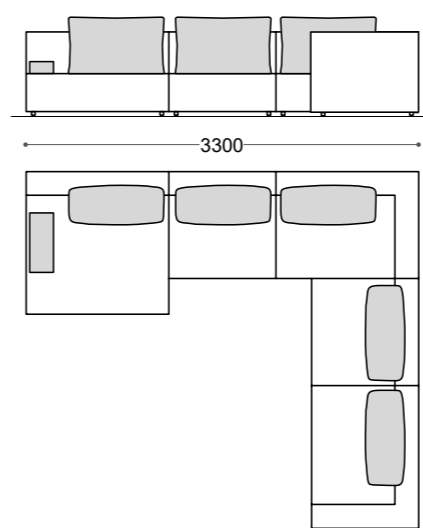

COMPOSIZIONE 360 CLCA 330 ACA

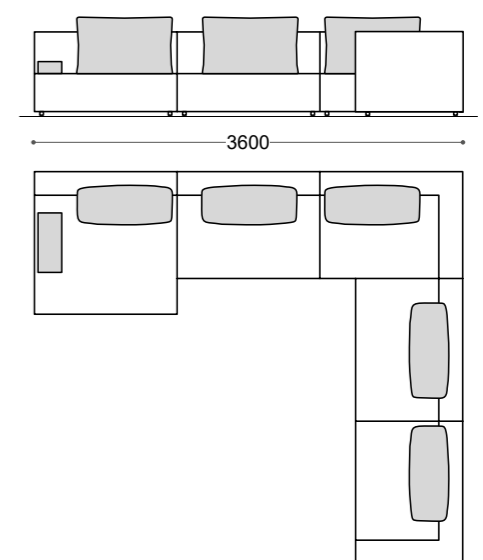

COMPOSIZIONE 265 BCLPCLB

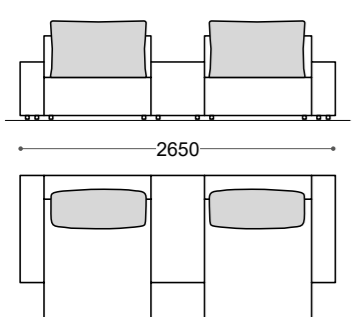

COMPOSIZIONE 435 PPCLPCLPP

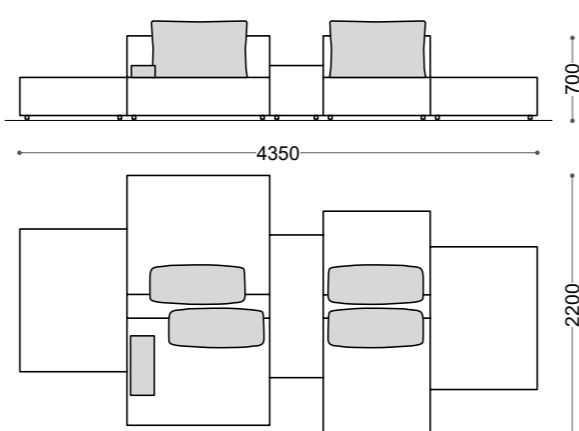

Sempre al centro della
scena ricco di dettagli
con infinite soluzioni
compositive

*Always at the center of
attention in countless
compositions with
luxurious details.*



MODEL 2

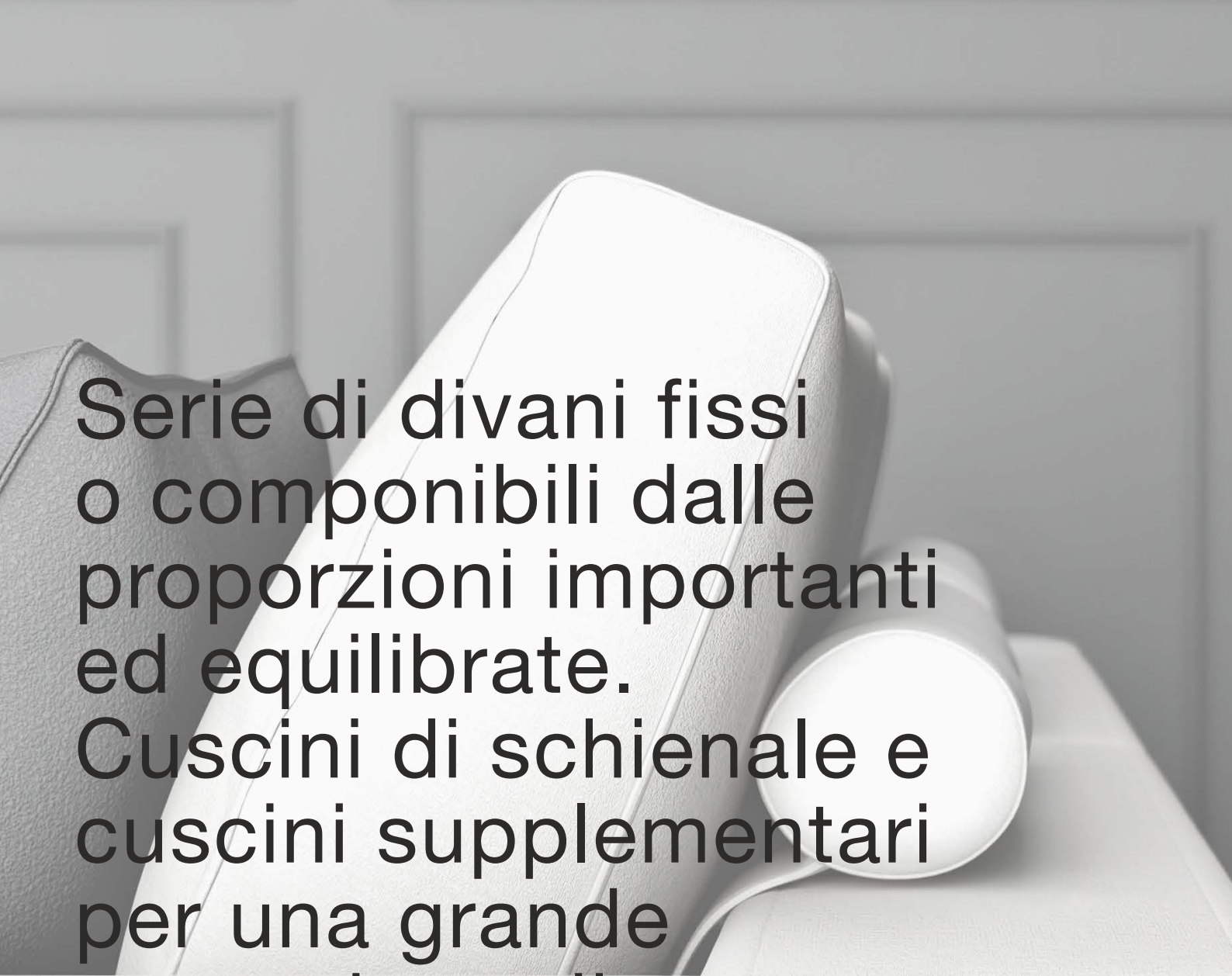

Serie di divani fissi o componibili dalle proporzioni importanti ed equilibrate. Cuscini di schienale e cuscini supplementari per una grande sensazione di accoglienza e comodità.

Series of fixed or modular sofas with balanced proportions. Backrest and additional pillows for sensation of great comfort. (for high standards of comfort).



DIVANO 290 105 D
SOFA 290 105 D

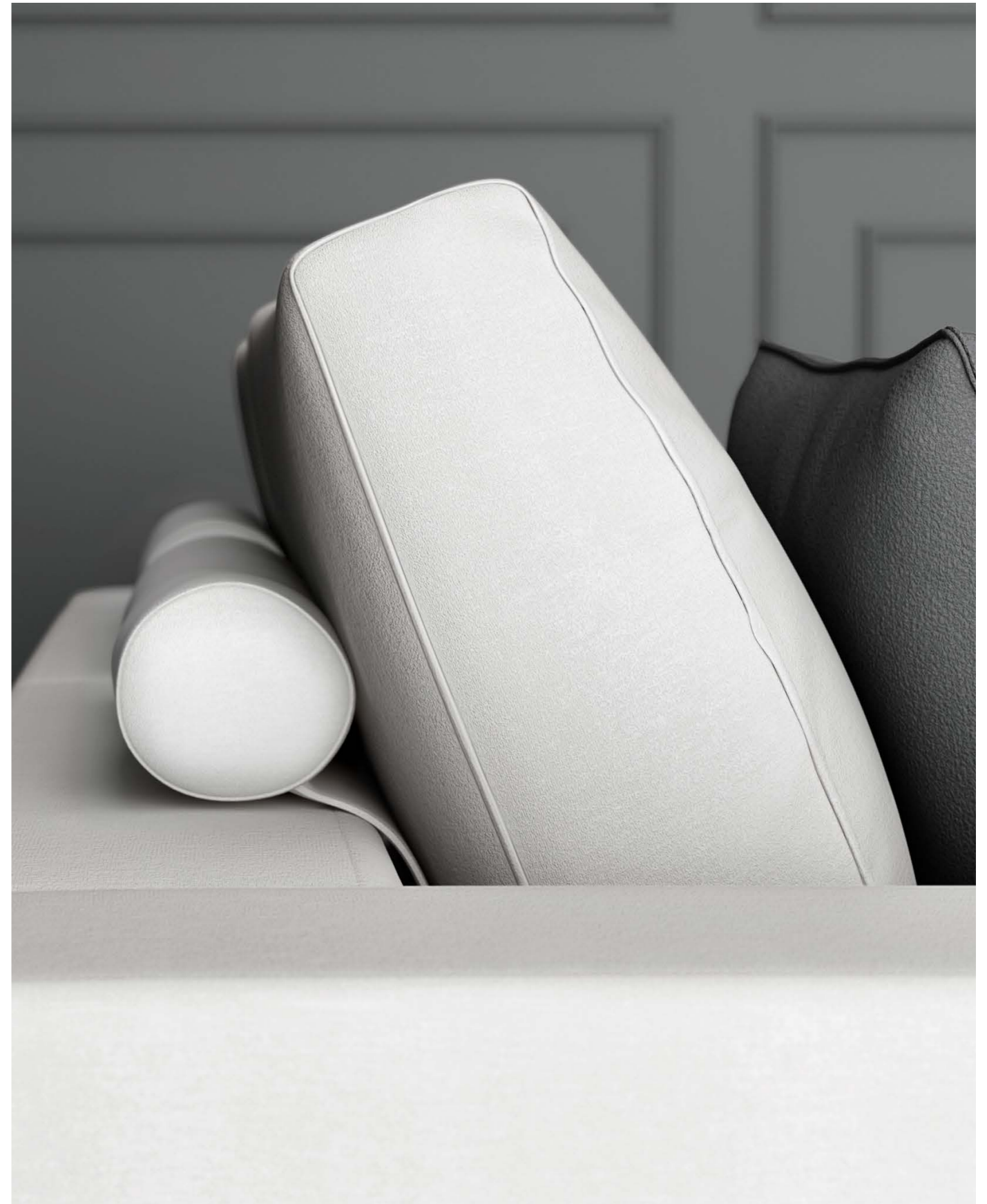









COMPOSIZIONE 285 CCA 400 APCL
COMPOSITION 285 CCA 400 APCL

DIVANO 230 105 D

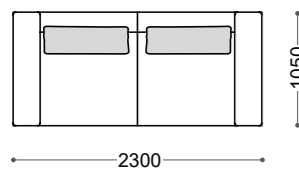

DIVANO 260 105 D

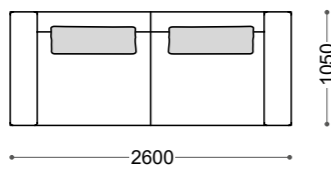

DIVANO 290 105 D

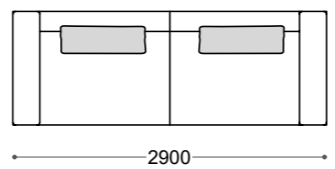

COMPOSIZIONE 310TCA 400ACCCL

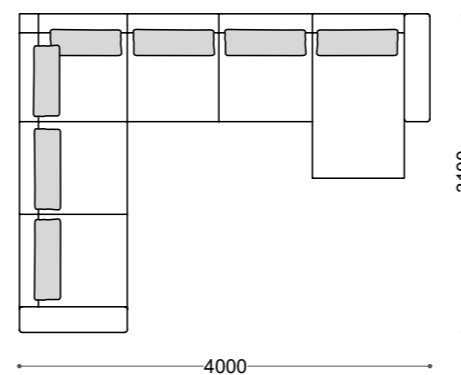

COMPOSIZIONE 370PTCA 490ACCCL

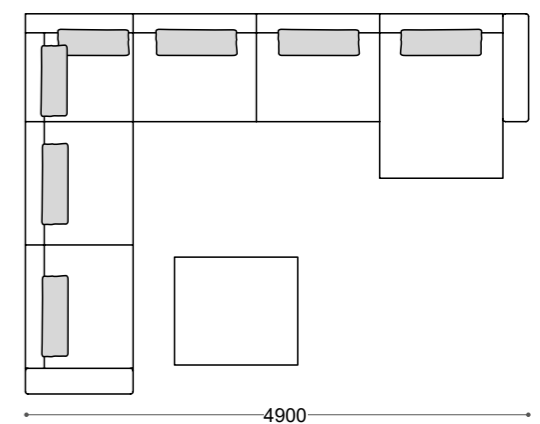

COMPOSIZIONE 290CLCT

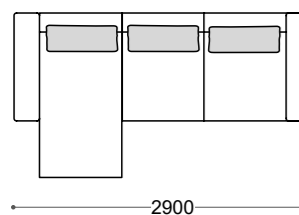

COMPOSIZIONE 320 CLCT

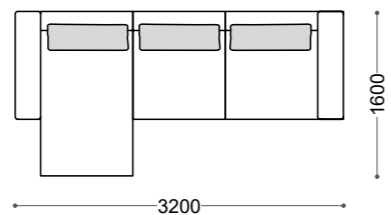

COMPOSIZIONE 285 CCA 400 APCCL

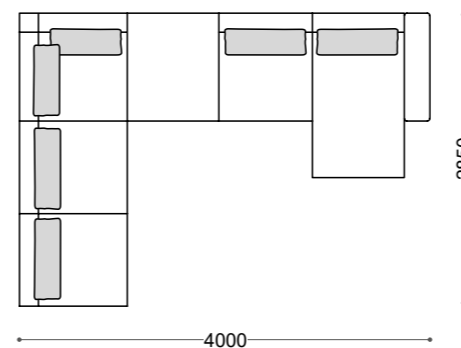

COMPOSIZIONE 365 CLCT

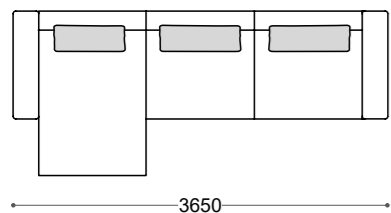

COMPOSIZIONE 210TA 290 ACT

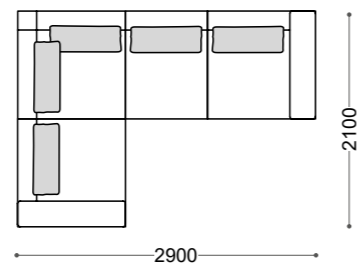

COMPOSIZIONE 250TA 370ACT

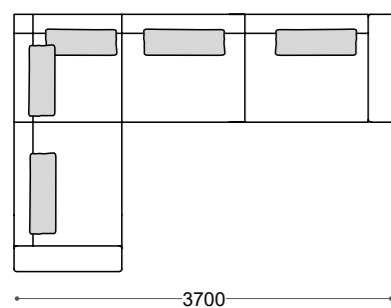

COMPOSIZIONE 250TA 445 ACCCL

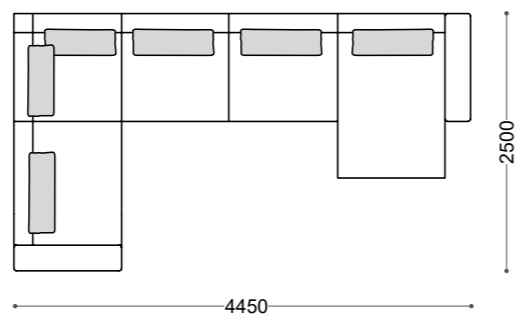

Leggero ed elegante
dal comfort composto
e raffinato.

*Lightweight and
elegant refined
comfort.*



MODEL 3

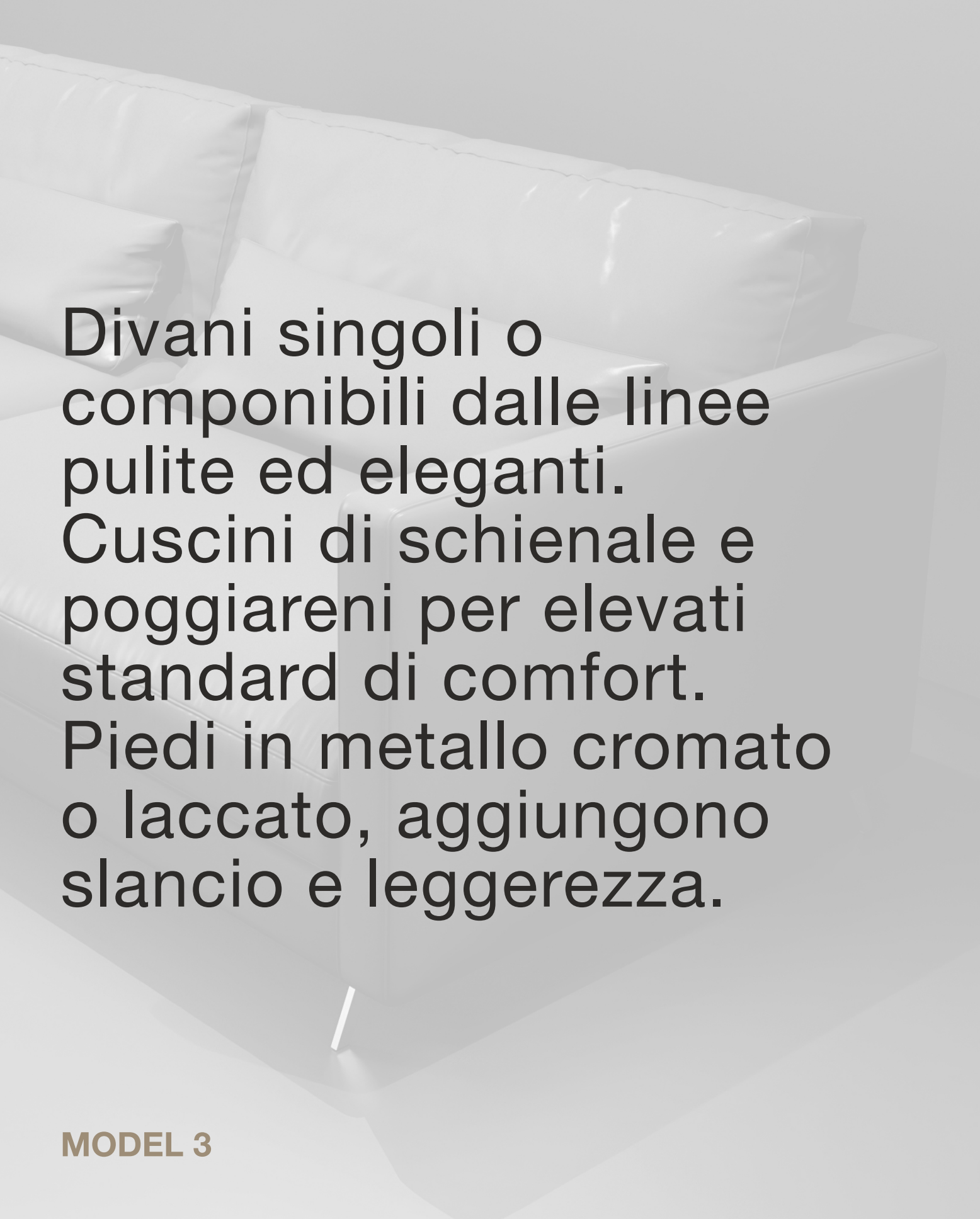

Divani singoli o componibili dalle linee pulite ed eleganti. Cuscini di schienale e poggiatesta per elevati standard di comfort. Piedi in metallo cromato o laccato, aggiungono slancio e leggerezza.

Single-seater or modular sofas with simple and elegant lines. Backrest and additional pillows for great comfort. Legs in chromed or lacquered metal to add design, style and lightweight.

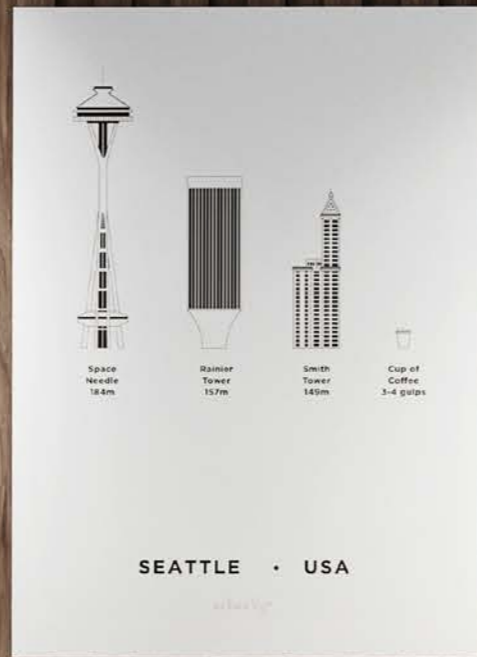



DIVANO 220 100 D2
SOFA 220 100 D2







DIVANO 220 100 D
SOFA 220 100 D



DIVANO 160 100 D

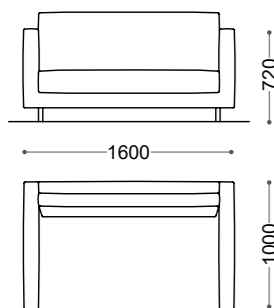

DIVANO 180 100 D

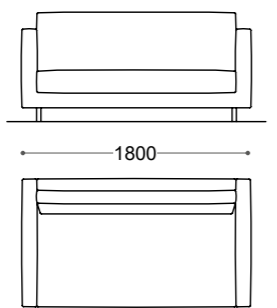

DIVANO 200 100 D

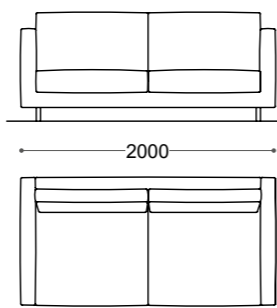

COMPOSIZIONE 340 CLT

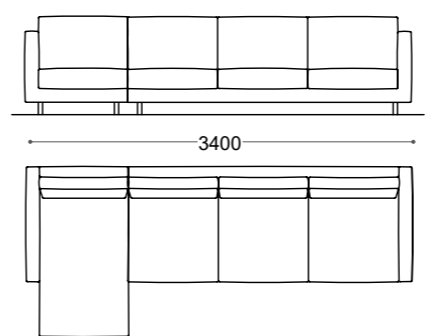

COMPOSIZIONE 380 CLT

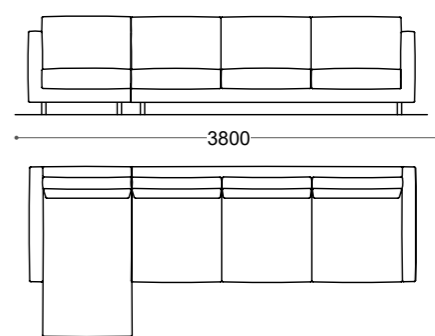

DIVANO 220 100 D

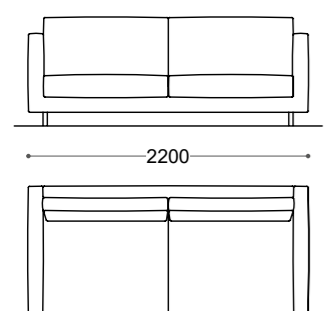

DIVANO 260 100 D2

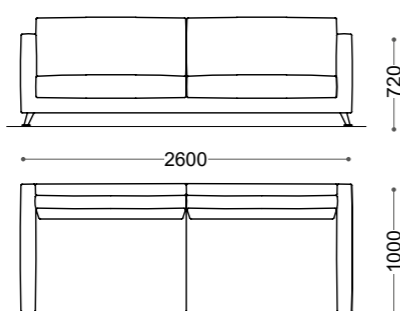

DIVANO 260 100 D3

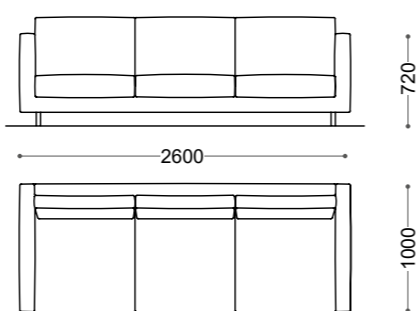

COMPOSIZIONE 290 290 CLTT

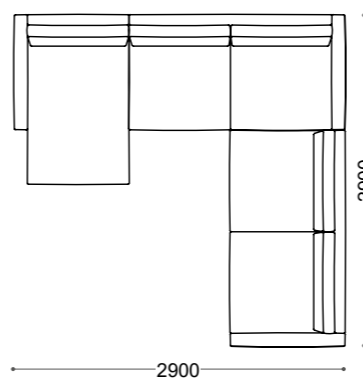

COMPOSIZIONE 380 290 TTTP

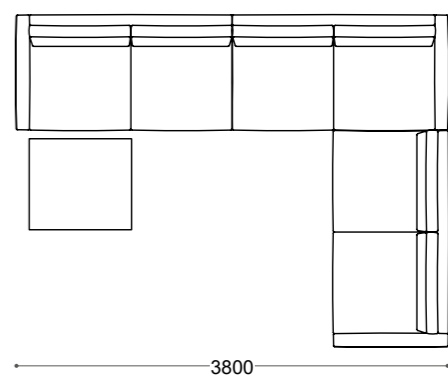

COMPOSIZIONE 260 CLT

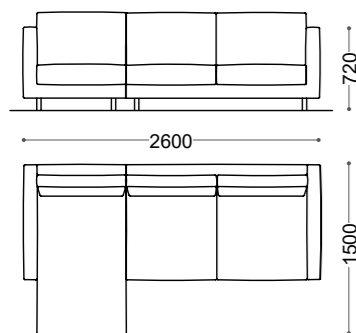

COMPOSIZIONE 290 CLT

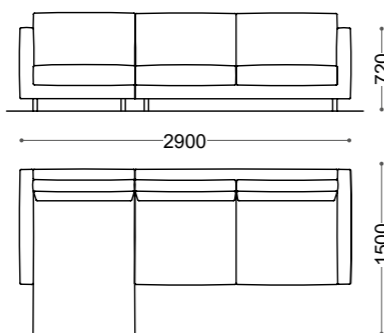

COMPOSIZIONE 320 CLT

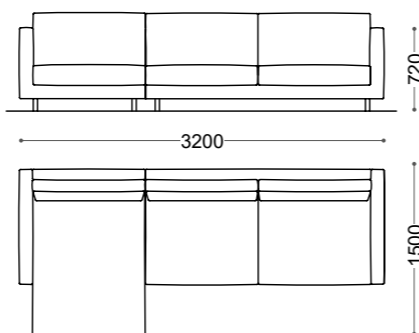

COMPOSIZIONE 380 350 CLTT

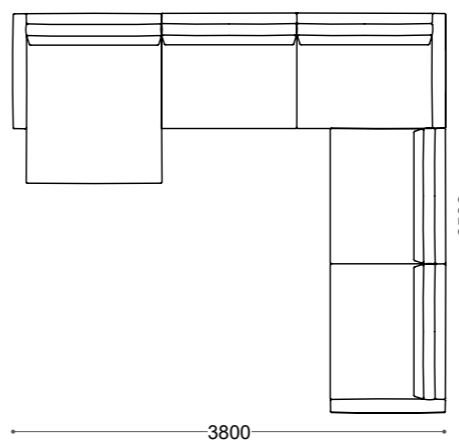

COMPOSIZIONE 320 310 CLTT

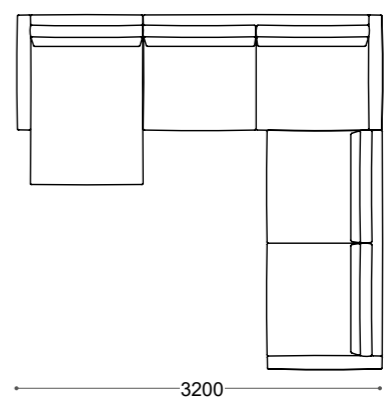

Specifiche suscettibili di variazioni senza preavviso
Specifications are subject to modification without notice

graphic /
SolutionStudio

image /
SolutionStudio

brera

via Giovanni Songia, 10
22066 Mariano Comense
C O M O - I T A L Y
C.F. 03306460134
tel. +39 031.3551194
fax +39 031.3554119
info@designbrera.it
www.designbrera.it